

Water Treatment



ATHENA PR

ELECTROMAGNETIC DOSING PUMPS
WITH BUILT IN PH/ORP CONTROLLER



Main characteristics

- PVDF PUMP HEAD suitable for chemical used in the Industrial applications, waste water treatment and potable water applications.
- CERAMIC BALL full chemical compatibility.
- PTFE DIAPHRAGM unique life expectancy and compatibility with most chemicals.
- STEADY DOSING
- Stabilized Multi Power Supply 100÷240 Vac 50/60 Hz with reduced consumption.
- QUICK CONNECTIONS; MANUAL PRIMING VALVE
- IP65 PROTECTION
- ADJUSTABLE FLOW RATE by buttons on the front panel.
- POWER-ON and LEVEL ALARMS LED.
- DIGITAL PROPORTIONAL FLOW WITH pH/Rx INSTRUMENTS
- Measuring range: pH 0÷14 - Rx -999÷+999 mV
- Automatic temperature compensation (optional)
- 4 ÷ 20 mA output on all the recording scale
- Manual / automatic calibration with probe efficiency evaluation
- Anti-seepage system

Water Treatment



Athena – Performance data

FLOW RATES	PRESSURES	CC/IMP.	CONNECTIONS	STROKES/MIN.	CONSUMPTION	WEIGHT	MODELS
2,5 l/h	20 bar	0,35	4x6 – 4x7	120	14 watt	3 kg	Athena 1
3 l/h	18 bar	0,42	4x6 – 4x7	120	14 watt	3 kg	
4,2 l/h	14 bar	0,58	4x6 – 4x7	120	14 watt	3 kg	
7 l/h	8 bar	0,97	4x6 – 4x7	120	14 watt	3 kg	
3 l/h	12 bar	0,31	4x6	160	20 watt	3 kg	Athena 2
4 l/h	10 bar	0,42	4x6	160	20 watt	3 kg	
5 l/h	8 bar	0,52	4x6	160	20 watt	3 kg	
8 l/h	2 bar	0,83	4x6	160	20 watt	3 kg	
7 l/h	16 bar	0,39	4x6	300	40 watt	4 kg	Athena 3
10 l/h	10 bar	0,56	4x6	300	40 watt	4 kg	
15 l/h	5 bar	0,83	4x6	300	40 watt	4 kg	
18 l/h	1 bar	1,00	4x6	300	40 watt	4 kg	
20 l/h	5 bar	1,11	8x12	300	40 watt	4 kg	Athena 4
32 l/h	4 bar	1,78	8x12	300	40 watt	4 kg	
62 l/h	2 bar	3,44	8x12	300	40 watt	4 kg	
110 l/h	0,1 bar	6,11	8x12	300	40 watt	4 kg	

Water Treatment

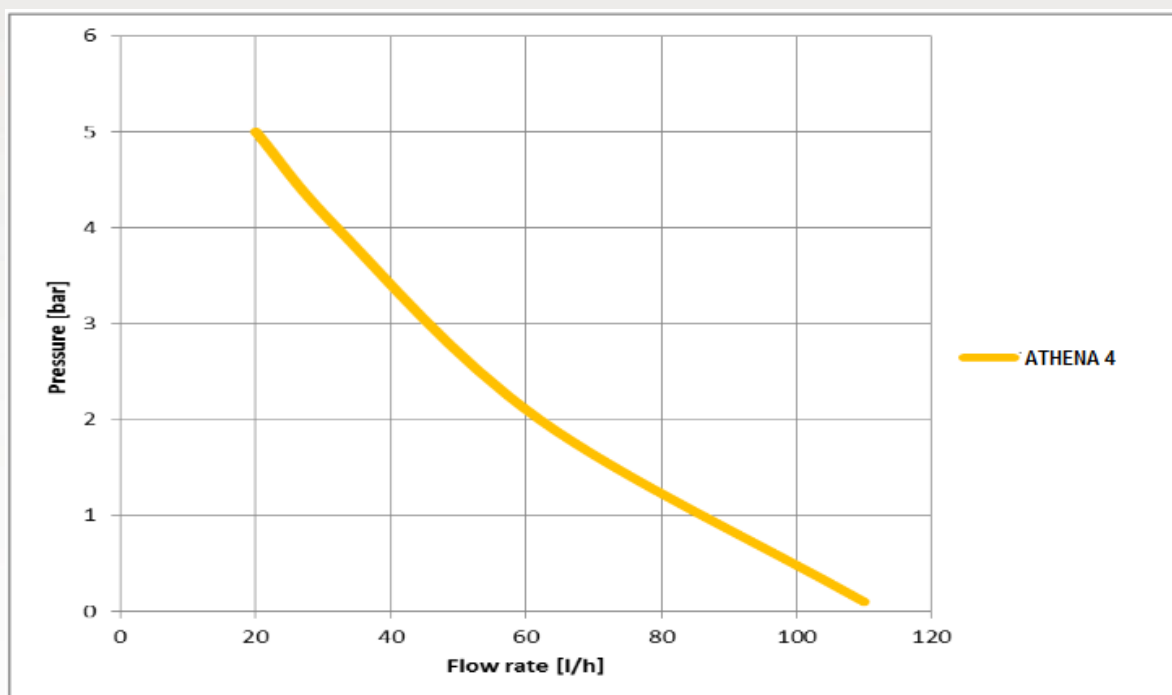
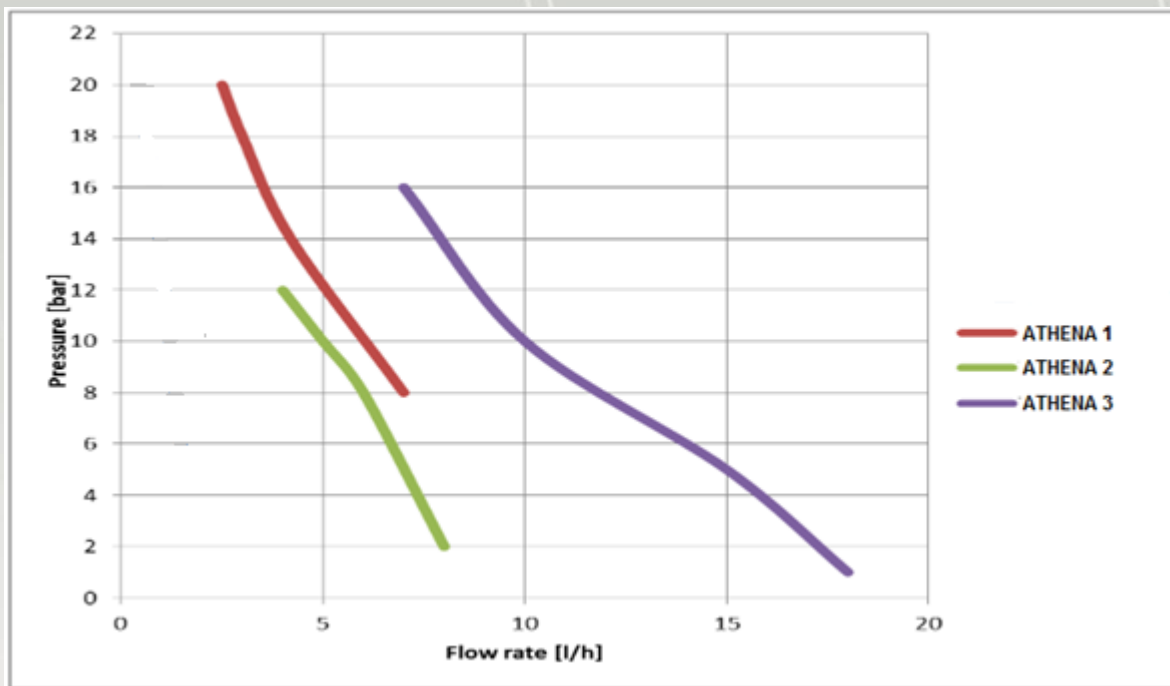

Water Treatment



Anti-seepage system

The anti-seepage system, is a solution to prevent the intrusion of chemical product inside the pump: leakage and chemical intrusion can happen when the O-ring is damaged or consumed by regular use.

This device is integrated in the hydraulic part, between pump head and body, behind the diaphragm: the outgoing collection channel of the anti-seepage device (see below blue arrow) collects the leakage and expel it out.

When the leakage is visible, the operator can proceed either tightening the 4 bolts of the head (4Nm torque) or disassembling the head and inspect it in order to understand leakage causes .

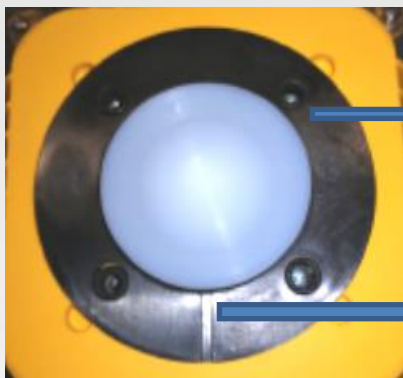

Anti-seepage device

collection channel

Water Treatment



Main applications

- Electroplating industry, Pickling, Degreasing and metal treatment.
- Cooling Tower.
- Swimming pool
- Potable water
- Reverse osmosis
- Paper industry
- Ceramic industry

Example of installation











Water Treatment



Installation kit



Accessories

<p>AC.VSA (ATHENA.1 .2 .3)</p>  <ul style="list-style-type: none"> • PvdF Pump head with automatic bleed valve • Flow reduction, according to the quantity of air in the liquid 	<p>AC.VM PVDF</p>  <ul style="list-style-type: none"> • Multifunction valve, antisiphon, backpressure, safety • PVDF body, PTFE membrane • Adjustable Pressure 0÷5 bar • Relief Pressure 0÷18 bar 	<p>AC.SF</p>  <ul style="list-style-type: none"> • Flow sensor • FPM Seals • 4x6 / 8x12 connections
<p>AC.SL</p>  <ul style="list-style-type: none"> • Floating level probe with bipolar cable (2 mt) with support 	<p>AC.ST</p>  <ul style="list-style-type: none"> • Horizontal base mounting bracket 	<p>PRIMING AID</p>  <p>Capacity</p> <ul style="list-style-type: none"> • Capacity: 300 ml • PVC Body • FPM seals • Connection: 4x6mm-8x12mm
<p>AC.VIE</p>  <ul style="list-style-type: none"> • Extractable injection valve PVC 1/2" g.m. IN - 1/2" g.m. OUT  <ul style="list-style-type: none"> • Extractable injection valve with ball valve PVC 1/2" g.m. IN - 1/2" g.m. OUT 	<p>AC.VS</p>  <ul style="list-style-type: none"> • Back-pressure valve up to 10 bar • PTFE diaphragm 	

Water Treatment



Dimensional drawings

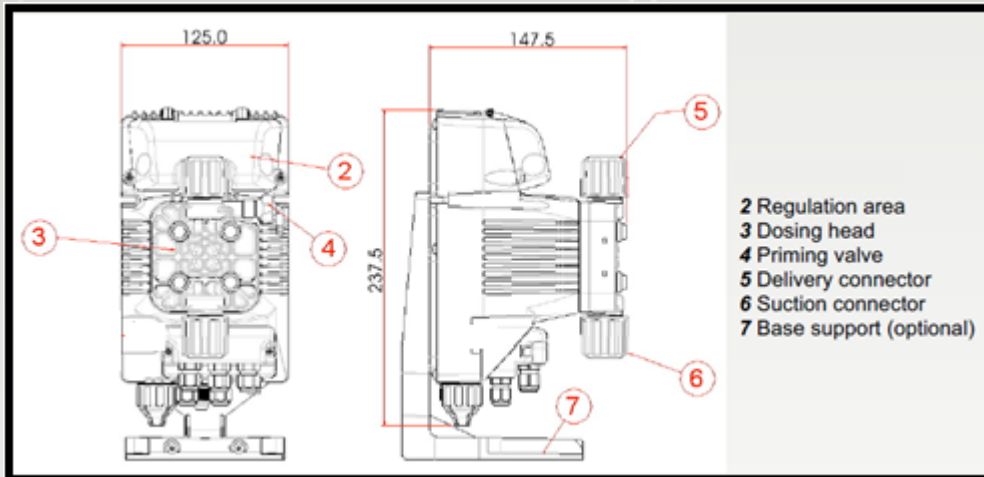

Plumbing

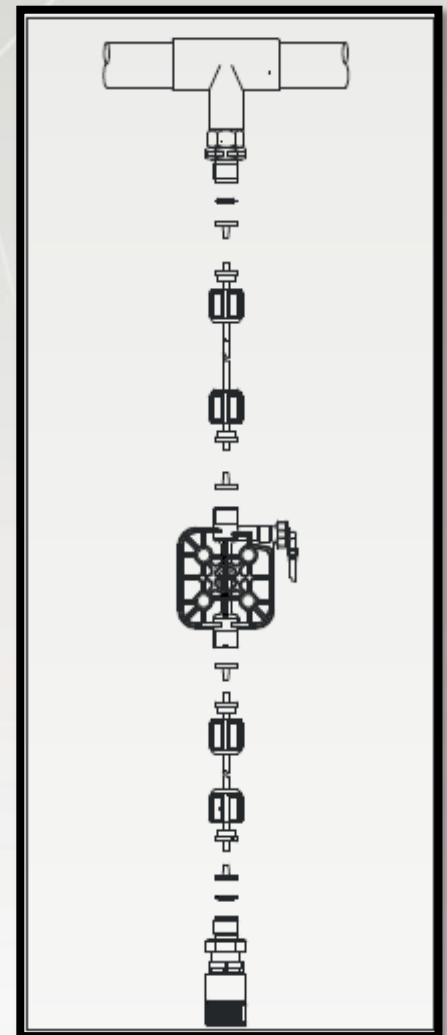

Fixing templates

